

pompa finale - serie XV

POMPA FINALE SAGOMATA
BASE ø36,5 FEMMINA SAGOMATA

X2F-2

X 2 F 51 72 Q P O A

Serie	X	serie XV
Gruppo	2	gruppo 2
Categoria	F	pompa finale
Cilindrata	51	17
Base	72	Ø36.5 femmina sagomata rotazione destra 2P+2P
Albero	Q	SCF01 - Finale
Corpo	IN	aspirazione - Ø40 Ø20 M8
	OUT	mandata - Ø30 Ø13.5 M6
Coperchio	A	standard

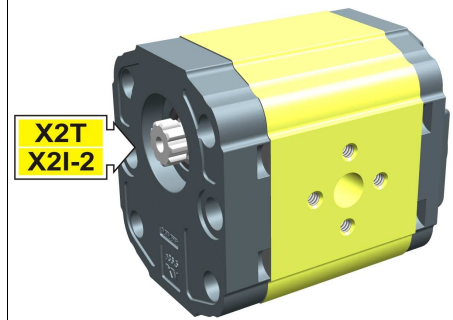

XF202

Tabella dati tecnici

TIPO	Cilindrata cm ³ /giro	Pressione Max.		CODICE																	
		P1 bar	P3 bar	Rotazione Sinistra			Rotazione destra														
X2F-2/04	4,20	260	300	X	2	F	41	71	Q	O	O	A	X	2	F	41	72	Q	O	O	A
X2F-2/06	6,00	260	300	X	2	F	43	71	Q	O	O	A	X	2	F	43	72	Q	O	O	A
X2F-2/09	8,40	260	300	X	2	F	45	71	Q	O	O	A	X	2	F	45	72	Q	O	O	A
X2F-2/11	10,80	260	300	X	2	F	47	71	Q	O	O	A	X	2	F	47	72	Q	O	O	A
X2F-2/14	14,40	250	290	X	2	F	49	71	Q	P	O	A	X	2	F	49	72	Q	P	O	A
X2F-2/17	16,80	230	270	X	2	F	51	71	Q	P	O	A	X	2	F	51	72	Q	P	O	A
X2F-2/19	19,20	210	250	X	2	F	53	71	Q	P	O	A	X	2	F	53	72	Q	P	O	A
X2F-2/22	22,80	200	240	X	2	F	55	71	Q	P	O	A	X	2	F	55	72	Q	P	O	A
X2F-2/26	26,20	170	210	X	2	F	57	71	Q	Q	P	A	X	2	F	57	72	Q	Q	P	A
X2F-2/30	30,00	160	200	X	2	F	59	71	Q	Q	P	A	X	2	F	59	72	Q	Q	P	A
X2F-2/34	34,20	150	190	X	2	F	61	71	Q	Q	P	A	X	2	F	61	72	Q	Q	P	A
X2F-2/40	39,60	140	180	X	2	F	63	71	Q	Q	P	A	X	2	F	63	72	Q	Q	P	A

P1) Pressione max. di esercizio - P3) Pressione max. di picco

Per applicazioni gravose si consiglia di verificare la coppia ammissibile dell'albero

Tabella dimensioni

TIPO	Peso kg	A	B	D	E	F	D	E	F
		mm	mm	IN			OUT		
X2F-2/04	2,200	87,2	41,7	ø13,5	30	M6x1	ø13,5	30	M6x1
X2F-2/06	2,300	90,2	43,2	ø13,5	30	M6x1	ø13,5	30	M6x1
X2F-2/09	2,400	94,2	45,2	ø13,5	30	M6x1	ø13,5	30	M6x1
X2F-2/11	2,500	98,2	47,2	ø13,5	30	M6x1	ø13,5	30	M6x1
X2F-2/14	2,700	104,2	50,2	ø20	40	M8X1,25	ø13,5	30	M6x1
X2F-2/17	2,800	108,2	52,2	ø20	40	M8X1,25	ø13,5	30	M6x1
X2F-2/19	2,900	112,2	54,2	ø20	40	M8X1,25	ø13,5	30	M6x1
X2F-2/22	3,050	118,2	57,2	ø20	40	M8X1,25	ø13,5	30	M6x1
X2F-2/26	3,150	122,2	59,2	ø23,5	40	M8X1,25	ø20	40	M8X1,25
X2F-2/30	3,400	130,2	63,2	ø23,5	40	M8X1,25	ø20	40	M8X1,25
X2F-2/34	3,600	137,2	66,7	ø23,5	40	M8X1,25	ø20	40	M8X1,25
X2F-2/40	3,800	146,2	71,2	ø23,5	40	M8X1,25	ø20	40	M8X1,25

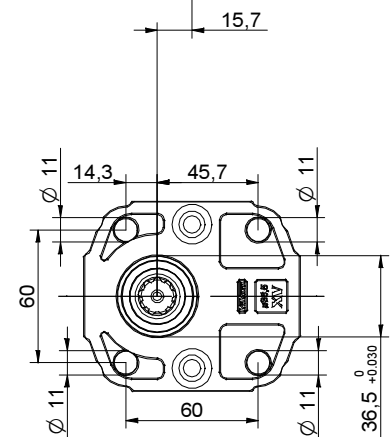
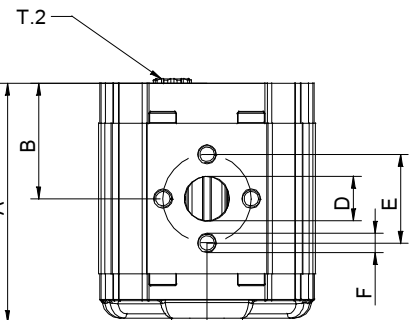
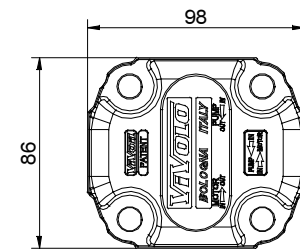





29/04/08 X2F5172I0P0A.dft

T.2 = 86.2 [Nm] - coppia ammissibile dell'albero (N.B. Per la scelta dell'albero verificare sempre la coppia ammissibile).

Tavola delle varianti

X2F-2

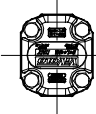
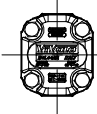
BASE ø36,5 Femmina Sagomata

BASE ø36,5 Femmina Sagomata		Albero		Coperchio	
Rotazione Sinistra	Rotazione destra			Rotazione Sinistra	Rotazione destra
	71		72		
		SCF01 - Scanalato T.2 = 86.2 [Nm] m=1,6 Z=9 DIN 5482 - 17x14 		Q	

Cilindrata	
TIPO	CODICE
X2F-2/04	41
X2F-2/06	43
X2F-2/09	45
X2F-2/11	47
X2F-2/14	49
X2F-2/17	51
X2F-2/19	53
X2F-2/22	55
X2F-2/26	57
X2F-2/30	59
X2F-2/34	61
X2F-2/40	63

Corpi standard						
Cilindrata	cm3/giro	Filettature standard				
		4	O - O	S - R	B - B	L - M
6	O - O	S - R	B - B	L - M	Z - Z	
9	O - O	S - R	B - B	L - M	Z - Z	
11	O - O	S - R	B - B	L - M	Z - Z	
14	P - O	S - R	C - B	L - M	Z - Z	
17	P - O	S - R	C - B	L - M	Z - Z	
19	P - O	S - R	C - B	L - M	Z - Z	
22	P - O	S - R	C - B	L - M	Z - Z	
26	Q - P	S - R	D - C	L - M	Z - Z	
30	Q - P	S - S	D - C	L - M	Z - Z	
34	Q - P	S - S	D - C	L - M	Z - Z	
40	Q - P	S - S	D - C	L - M	Z - Z	

Tabella con indicate le combinazioni delle flangiature e filettature standard disponibili a magazzino

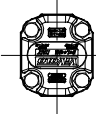
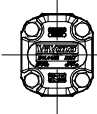
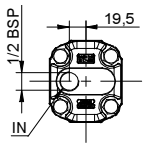
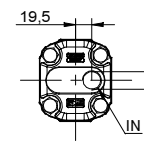
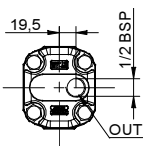
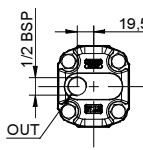
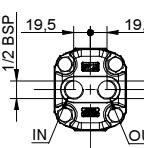
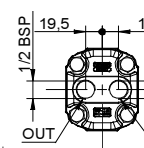
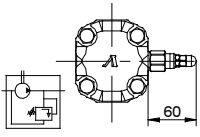
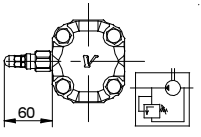
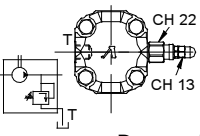
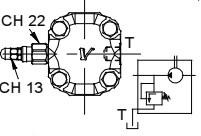
Coperchio		
Rotazione Sinistra	Rotazione destra	
		A
		B
		C
		D
		N
Drenaggio interno		
		O
Drenaggio esterno		

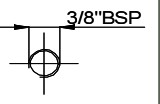
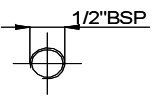
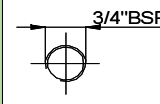
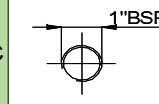
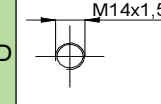
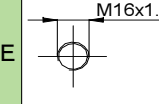
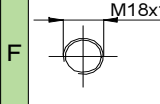
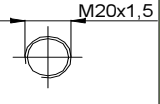
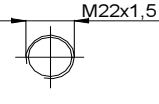
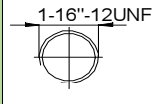
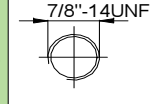
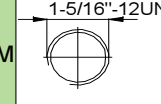
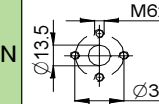
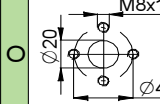
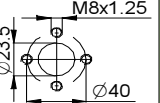
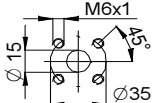
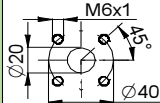
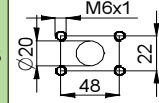
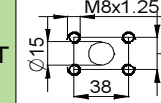
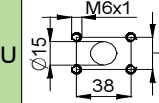
Corpo (filettature e flangiature)													
	A		B		C		D		E		F		G
	H		I		L		M		N		O		P
	Q		R		S		T		U		V	Corpo Chiuso Z	