

motore unidirezionale - serie XV

XV-2U

MOTORE UNIFICAZIONE TEDESCCA
BASE ø80 - ALBERO CONICO

X 2 U 51 42 F S R A

Serie	X	serie XV
Gruppo	2	gruppo 2
Categoria	U	motore unidirezionale
Cilindrata	51	17
Base	42	Ø80 UNIFICAZIONE TEDESCCA rotazione destra (con OR)
Albero	F	CO002 - Conico 1:5 - ø17.4 - M12x1.5 - linguetta sp.3
Corpo	IN	aspirazione - Ø40 a 45° Ø20 M6
	OUT	mandata - Ø35 a 45° Ø15 M6
Coperchio	A	standard

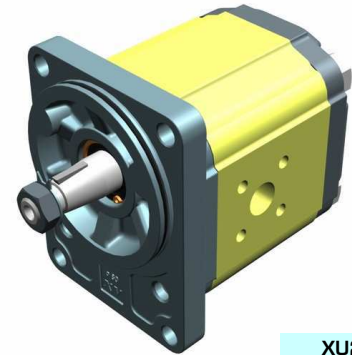

XU217

Tabella dati tecnici

TIPO	Cilindrata cm ³ /giro	Pressione Max.		CODICE	
		P1 bar	P3 bar	Rotazione Sinistra	Rotazione destra
XV-2U/04	4,20	260	300	X 2 U 41 41 F S R A	X 2 U 41 42 F S R A
XV-2U/06	6,00	260	300	X 2 U 43 41 F S R A	X 2 U 43 42 F S R A
XV-2U/09	8,40	260	300	X 2 U 45 41 F S R A	X 2 U 45 42 F S R A
XV-2U/11	10,80	260	300	X 2 U 47 41 F S R A	X 2 U 47 42 F S R A
XV-2U/14	14,40	250	290	X 2 U 49 41 F S R A	X 2 U 49 42 F S R A
XV-2U/17	16,80	230	270	X 2 U 51 41 F S R A	X 2 U 51 42 F S R A
XV-2U/19	19,20	210	250	X 2 U 53 41 F S R A	X 2 U 53 42 F S R A
XV-2U/22	22,80	200	240	X 2 U 55 41 F S R A	X 2 U 55 42 F S R A
XV-2U/26	26,20	170	210	X 2 U 57 41 F S R A	X 2 U 57 42 F S R A
XV-2U/30	30,00	160	200	X 2 U 59 41 F S S A	X 2 U 59 42 F S S A
XV-2U/34	34,20	150	190	X 2 U 61 41 F S S A	X 2 U 61 42 F S S A
XV-2U/40	39,60	140	180	X 2 U 63 41 F S S A	X 2 U 63 42 F S S A

P1) Pressione max. di esercizio - P3) Pressione max. di picco

Per applicazioni gravose si consiglia di verificare la coppia ammissibile dell'albero

Tabella dimensioni

TIPO	Peso kg	A	B	C	D	E	F	D	E	F
		mm	mm	mm	IN			OUT		
XV-2U/04	2,330	89,7	41,1	79,7	ø15	35	M6x1	ø20	40	M6x1
XV-2U/06	2,430	92,7	41,1	82,7	ø15	35	M6x1	ø20	40	M6x2
XV-2U/09	2,530	96,7	43,1	86,7	ø15	35	M6x1	ø20	40	M6x3
XV-2U/11	2,630	100,7	47,5	90,7	ø15	35	M6x1	ø20	40	M6x4
XV-2U/14	2,730	106,7	47,5	96,7	ø15	35	M6x1	ø20	40	M6x5
XV-2U/17	2,830	110,7	47,5	100,7	ø15	35	M6x1	ø20	40	M6x6
XV-2U/19	2,930	114,7	47,5	104,7	ø15	35	M6x1	ø20	40	M6x7
XV-2U/22	3,180	120,7	55,0	110,7	ø15	35	M6x1	ø20	40	M6x8
XV-2U/26	3,280	124,7	55,0	114,7	ø15	35	M6x1	ø20	40	M6x9
XV-2U/30	3,530	132,7	63,2	122,7	ø20	40	M6x1	ø20	40	M6x10
XV-2U/34	3,730	139,7	63,2	129,7	ø20	40	M6x1	ø20	40	M6x11
XV-2U/40	3,930	148,7	63,2	138,7	ø20	40	M6x1	ø20	40	M6x12

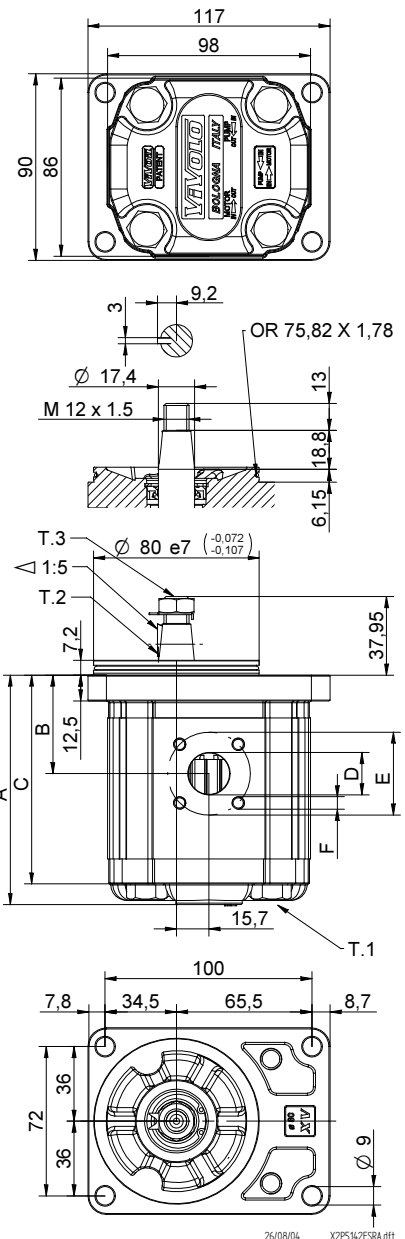

T.1 = 54÷58.9 [Nm] - coppia di serraggio viti M10

T.3 = 40 [Nm] - coppia di serraggio - chiave 19

T.2 = 233.2 [Nm] - coppia ammissibile dell'albero (N.B. Per la scelta dell'albero verificare sempre la coppia ammissibile).

Tavola delle varianti

XV-2U

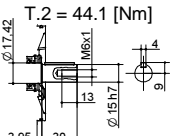
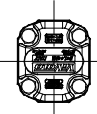
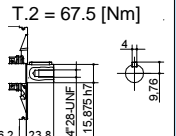
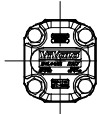
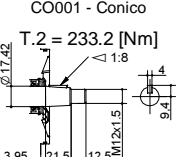
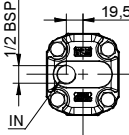
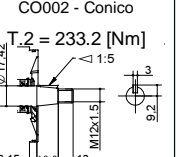
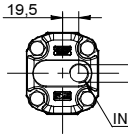
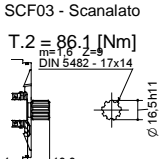
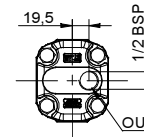
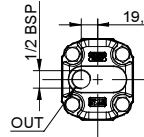
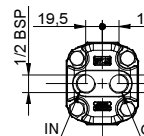
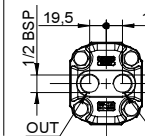
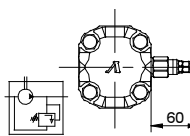
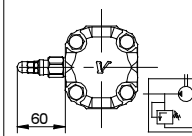
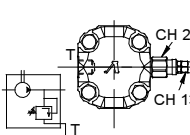
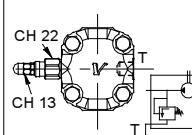

BASE ø80 unificazione tedesca

BASE ø80 unificazione tedesca		Albero		Coperchio	
Rotazione Sinistra	Rotazione destra			Rotazione Sinistra	Rotazione destra
	41		A		A
			B		A
			E		B
			F		B
			H		C
					C
					D
					D
					N
					N
					O
					O

Cilindrata	
TIPO	CODICE
XV-2U/04	41
XV-2U/06	43
XV-2U/09	45
XV-2U/11	47
XV-2U/14	49
XV-2U/17	51
XV-2U/19	53
XV-2U/22	55
XV-2U/26	57
XV-2U/30	59
XV-2U/34	61
XV-2U/40	63

Corpi standard						
Cilindrata	cm3/giro	Filettature standard				
4	O - O	S - R	B - B	L - M	Z - Z	
6	O - O	S - R	B - B	L - M	Z - Z	
9	O - O	S - R	B - B	L - M	Z - Z	
11	O - O	S - R	B - B	L - M	Z - Z	
14	P - O	S - R	C - B	L - M	Z - Z	
17	P - O	S - R	C - B	L - M	Z - Z	
19	P - O	S - R	C - B	L - M	Z - Z	
22	P - O	S - R	C - B	L - M	Z - Z	
26	Q - P	S - R	D - C	L - M	Z - Z	
30	Q - P	S - S	D - C	L - M	Z - Z	
34	Q - P	S - S	D - C	L - M	Z - Z	
40	Q - P	S - S	D - C	L - M	Z - Z	

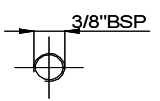
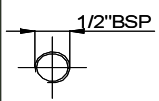
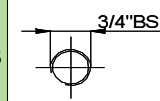
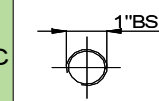
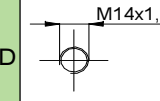
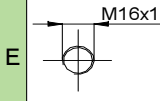
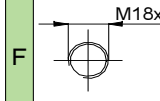
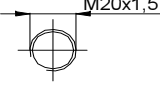
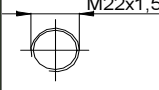
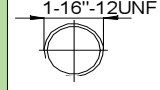
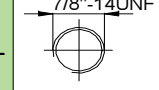
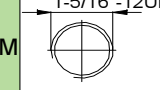
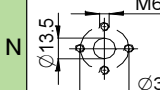
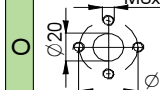
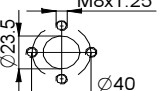
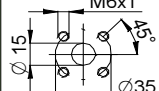
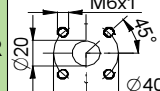
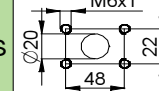
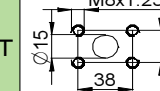
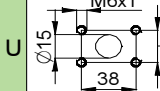
Tabella con indicate le combinazioni delle flangiate e filettature standard disponibili a magazzino

Corpo (filettature e flangiate)													
	A		B		C		D		E		F		G
	H		I		L		M		N		O		P
	Q		R		S		T		U		V		Z